

DIG A 5-METER-LONG TRENCH

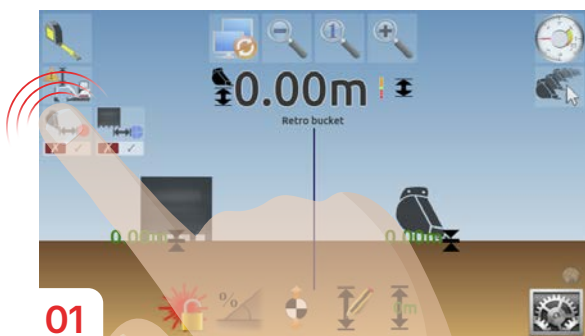

01

Click on the "Show/Hide Distance" icon on the left side of the screen.

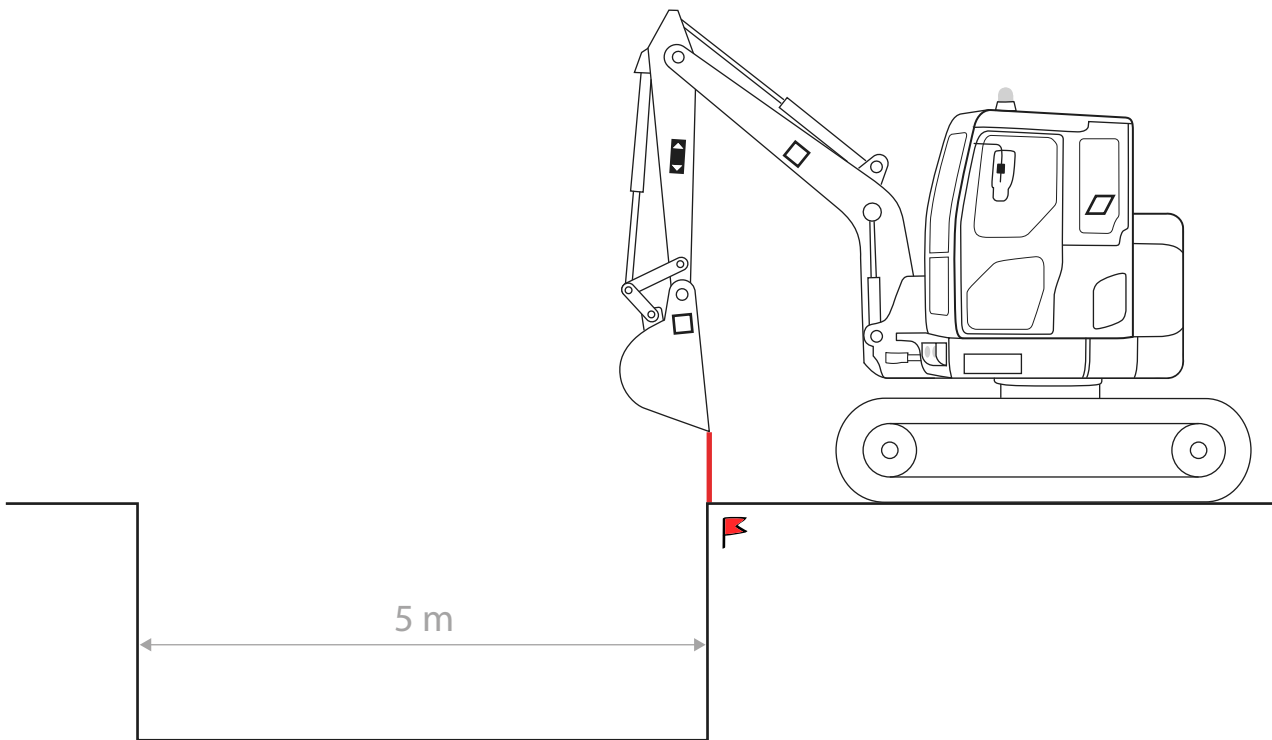
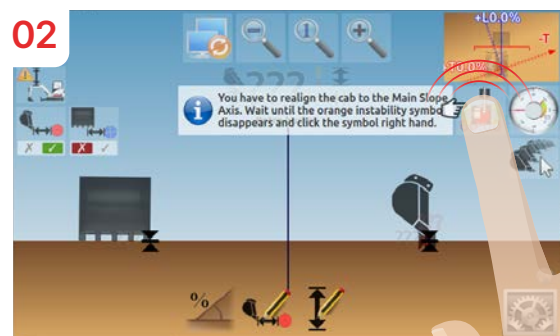

02

Align the cabin with the trench, then click on the alignment icon.

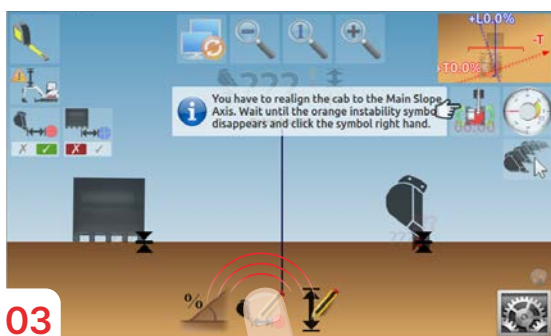

03

Position the bucket tip on the benchmark and click on "Edit distance measurement".

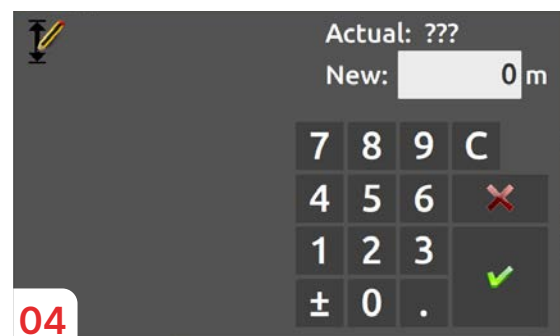

04

Enter the value 0.

DIG A 5-METER-LONG TRENCH

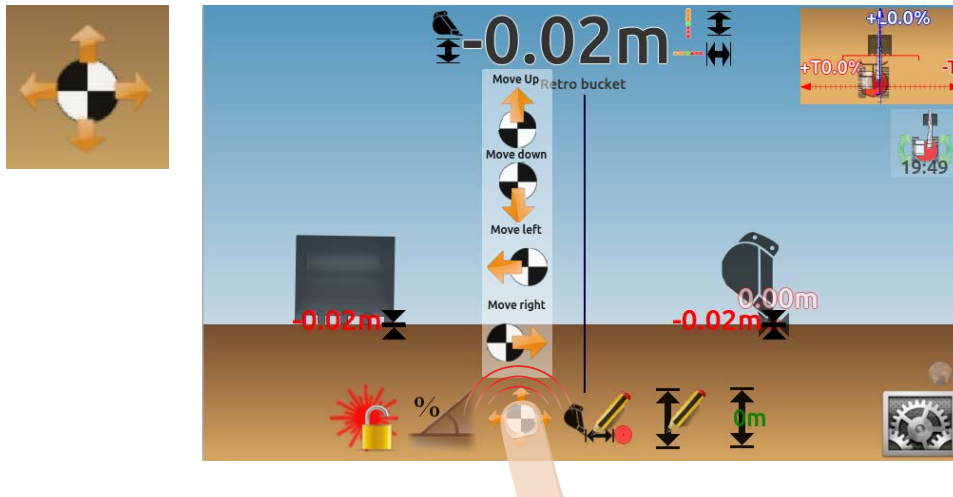

Case 1: Trench located beyond the benchmark.

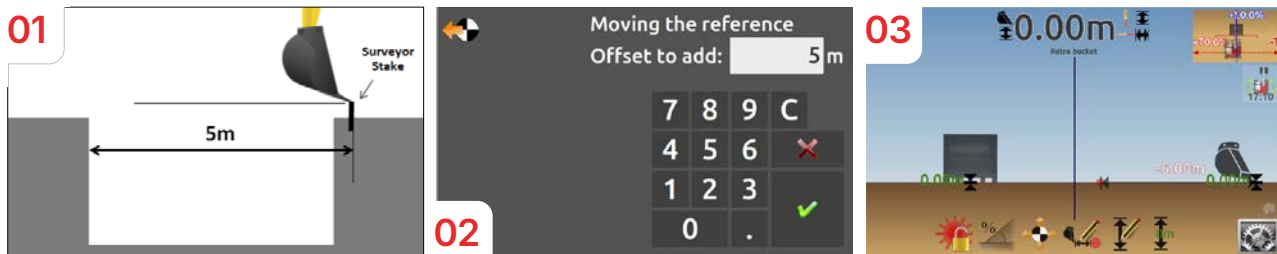

Case 2: Trench located in front of benchmark.

